

How the Mind Affects the Heart



Paul T E Cusack*

BSCE, DULE, 23 Park Ave, Saint john, NB E2J 1R2, Canada

Submission: June 16, 2023; **Published:** September 11, 2023

***Corresponding author:** PPaul T E Cusack, BSCE, DULE, 23 Park Ave. Saint john, NB E2J 1R2, Canada

Abstract

It has been known that the workings of the mind affect the heart. In this paper, we show, using AT Math, how that connection works. It is important because we live stressful lives in modern life. It can lead to heart disease.

Keywords: Heart; Mind; At Math

Introduction

The Mind and the heart work together. I dare say a lot of us die because of that. Our thinking leads us to strokes. It is stress that kills. In this paper, we show the chemical and mathematical link between the mind and the heart. We use AT Math, which we presume you are now familiar with as a powerful tool in the scientist's toolbox. We begin with the circuit of the human senses (Figure 1). The capacitance of the senses has been established in previous papers by this author. We make use of the simple L-R-C circuit.

We know from AT Math that Mass is equal to the ln function.

$$M = \ln t$$

$$= \ln (0.398)$$

$$= 1.3819$$

Cardiac Muscle Ions

$$\text{Na}^+ 22.998$$

$$\text{K}^+ 39.1$$

$$\text{Ca}^{++} = 40.078$$

$$\Sigma 102.176 \times 6.023 = 615.406$$

$$TE = 138.19 + 615.406 = 753.596 = 1/1327 = 1/s = E$$

$$2 \text{Na} + 3\text{K} + 1 \text{Ca} = 205 \text{amu}$$

$$205 \times 6.023 = 123.6 = 1/808 = M$$

$$M = 1/81 = -0.012345679$$

Iron in the Blood cursing through the heart:

Viscosity of blood

$$v = 106.6$$

$$106.6/5000 \text{m} \ell = 127.9$$

$$t = KE = 1/2 \rho v^2$$

$$= 1/2 (127.9) (1/\sqrt{2})^2$$

$$= 31.975 \approx 1/\pi$$

= Capacitance C

Mass of electron = 51099 x 4 charges = 204.39 ≈ 205 Cf cardiac ions

$$2262 \text{ mol of Fe} = 55.845 \times 6.023 = 760.83 \approx 1/s = E$$

A deficiency in Vit B12 results in anemia, lack of Fe in the blood.

The following balanced equation is for Hgb.

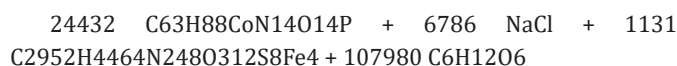

→

Vit B12 (Iron Def.) + Salt + HgB + Sugar

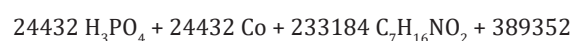



Phosphoric Acid +Cobalt +Acetylcholine +Serotonin
 Hydrogen Sulphide + 2262 Fe₂Cl₃
 equation(1)

+Sz

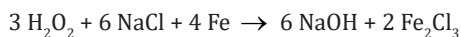

Nerve toxin & Carcinogen → Salt +Iron → Low Blood Pressure +Sz

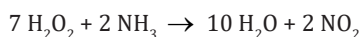

Hydrogen Peroxide + Urine → Water + Air Particulate pollution

NO@ could lead to cancer in the blood and the lung as established in previous papers.

From equation (1)

24432(1355.37)

+6786(58.44)

$$+1131(48900.40)+107980(180.16)$$

$$=179.66$$

$$\approx 180 = \pi = t = M/6.023$$

$$\text{Sugar } C_6H_{12}O_6 = 180.16$$

$$GMP : \pi^2 - 2 - 1 = 57.29^0 = 1 \text{ rad} = E$$

$$E = hv$$

$$= 6.626(106.6)$$

=706.3 ≈ 1/√2 = V = a ⇒ y = y' This evokes the AT Math solution.

$$V \times t = 1/\sqrt{2} \times 180 = 126.89 = 126.89 = \text{moles of Hgb}$$

$$1/\sqrt{2} \times \pi = 2.2189 \approx 2/9 = t/c^2 = M$$

$$tM = 4\pi = 125.66 = E_{\min} \text{ of the GMP } t_{\min} = 1/2$$

$$125.66/(1/2) = 0.0251 = 1/398 = 1/s \text{ Cf Figure 1}$$

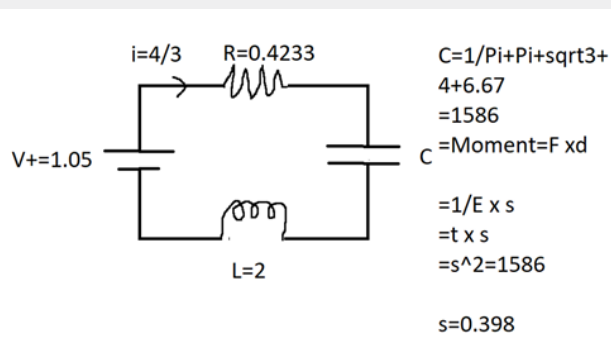

Figure 1: The Brain circuit with 5 senses as capacitors.

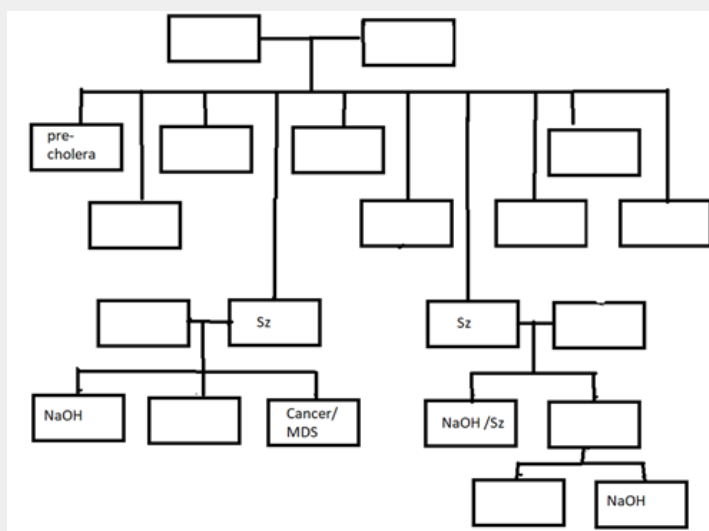

Figure 2.

In a patient's family tree, there were two children of 9post cholera of the mother who had Schizoid personality. There were 3 offspring who had low blood pressure. There were 7 offspring all together (Figure 2).

$$2/9 \times 3/7 = 1/105 = 1/V+$$

$$V=iR$$

$$0.0952=4/3(0.4233-2+(\pi +1/\pi + 4+6.67+\sqrt{3}))$$

$$0.0952(3)/4=0.0714/0.1428$$

$$=5002\text{ml of blood}$$

$$120-80$$

$$=40\text{mm Hg}=5.333\text{kPa}$$

$$=2(8/3) = 1/5000(F)$$

$$25\text{mm Hg} \times 5.333 = 133.3 = s$$

Bernoulli's Equation

$$P + 1/2\rho V^2 + \rho gh = C = E = 1$$

$$p + 1/2(106.6) (1/\sqrt{2}) + (106.6)(9.806)(1) = 1$$

$$p = 36.103$$

$$\text{GMP: } 36.03^2 - 36.03 - 1 = 1338 \approx s$$

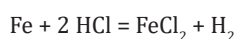

$$\text{pH} = \text{Ln} [\text{H}^+]$$

$$\text{Ln} [2(1.0078)/5000]$$

$$= 7.816 = 1/127.9 = 1/\rho = 1/(4/\text{Pi}) = \text{Pi}/4 = t$$

$$126.8 = \text{molar mass of FeCl}_2 = \text{Sz.}$$

$$\text{Fe } 55.845 \times 6.023 = 336.4$$

$$336.4/5000 \text{ ml of blood} = 6727$$

$$M = \text{Ln } t$$

$$\text{pH} = -\text{Ln} [\text{H}^+]$$

$$= -\text{Ln } 672$$

$$= 27$$

$$9 \times 3$$

$$= c^2t$$

$$9(\pi) = 28274$$

$$28.274/4 = 706.8 \approx 1/\sqrt{2} = v = a$$

$$E = hv = 6.626(1.066) = 706.3$$

The viscosity of blood would increase with dehydration. Cholera causes dehydration.

Conclusion

We see how the neurons affect the cardiac ions based on AT Math. More work is needed in this area.



This work is licensed under Creative Commons Attribution 4.0 License
DOI: [10.19080/OMCIJ.2023.12.555849](https://doi.org/10.19080/OMCIJ.2023.12.555849)

Your next submission with Juniper Publishers will reach you the below assets

- Quality Editorial service
- Swift Peer Review
- Reprints availability
- E-prints Service
- Manuscript Podcast for convenient understanding
- Global attainment for your research
- Manuscript accessibility in different formats (**Pdf, E-pub, Full Text, Audio**)
- Unceasing customer service

Track the below URL for one-step submission

<https://juniperpublishers.com/online-submission.php>