

The Investigation Illite Clay Strength Under Traffic Load

Viktoras Dorosevas^{1,2,3}, Vadimas Kitovas³ and Gediminas Stelmokaitis³

¹Faculty of Mechanics, Vilnius Gediminas Technical University (VILNIUS TECH), Vilnius, Lithuania

²Faculty of Technology, Klaipeda State University of Applied Sciences, Klaipeda, Lithuania

³Faculty of Civil Engineering and Architecture, Kaunas University of Technology, Kaunas, Lithuania

Submission: July 25, 2024; **Published:** August 05, 2024

***Corresponding author:** Viktoras Dorosevas, Faculty of Mechanics, Vilnius Gediminas Technical University (VILNIUS TECH), Vilnius, and Faculty of Technology, Klaipeda State University of Applied Sciences, Klaipeda, and Faculty of Civil Engineering and Architecture, Kaunas University of Technology, Kaunas, Lithuania

Abstract

Clay slopes and engineering structures built on them, excavations, and embankments are particularly sensitive to the effects of active soil vibrations. There are no common norms for assessing or in general evaluating the effect of soil vibrations on mechanical strength properties. Known methodologies and research methods are of general nature and insufficiently accurately assess the change of mechanical properties of soil under the influence of various vibrations. This is especially important when it comes to the safety of people in large cities that have different types of slopes, embankments, or excavations. The soil research methodology used in our study is relatively new and allows us to determine the change of mechanical properties of soils affected by vibrations depending on the frequency of vibrations. This work contains the analysis of the strength of illite clay of different density and humidity, affected by different vibrations caused by traffic load. It has been found that vibrations have a negative influence on oedometric strength and shearing strength, i.e. under unfavorable natural conditions, vibrations caused by trains, construction machinery, etc. greatly reduce the strength properties of clay. In the conclusions, it is recommended to use certain soil parameters that are more reliable for the design of structures in urban areas close to or on the slopes.

Keywords: Vibrations of traffic load; Strength; Cohesion; Angle of friction; Consolidation

Introduction

In structural design one of the most important factors that determine the longevity of structures is soil footing. Properties of soil and the conditions of soil-structure interaction determine the strength, stability, and normal operation of the structure. Therefore, a detailed analysis of soil is extremely important in structural design. In order to ensure the required durability of a structure all possible loads and environmental effects that could act at any time of structure operation must be determined. Soil may be affected by dead load of the structure, live loads, surface water, and groundwater, as well as, filtering pressure, temperature, creep, and vibrations. Vibrations in the soil can be produced by earthquakes and various anthropogenic external sources. The most common examples of vibration sources are road traffic, train loading, blasting, pile driving, and dynamic soil compaction. Naturally, vibrations in form of seismic waves are more dangerous to existing structures than vibrations from anthropogenic

activities. Seismic waves produced by strong earthquakes cause massive damage by triggering landslides, soil settlements, liquefaction, and the collapse of structures. However, in many regions of the world, Lithuania included, seismic activity is low and most of the ground vibrations come from anthropogenic sources. Recent studies showed that ground vibrations have a negative effect on soil strength. It is agreed that vibrations influence on soil mechanical properties is directly connected with the initial physical properties of the soil. The least amount of research in this area has been done studying the effect of vibrations on clay soil. Therefore, the aim of this paper is to study the behavior of clay subjected to different frequencies applied in a laboratory setting.

In order to study vibrations effect on clay soil parameters using laboratory equipment the frequency range of anthropogenic vibration sources must first be investigated. A lot of research has been performed to investigate man-made vibrations frequency

range in the last few decades. One of a study demonstrated that train loading generated vibrations frequency depends on the speed of the train, its geometry, rail stiffness and wheels roughness [1]. Another investigated vibrations measurements showed that in the soil passing trains caused ground vibrations with frequency range of 7-70 Hz [2]. The frequency of vibrations generated by passage of trains does not exceed 80 Hz [3]. The investigated ground vibrations caused by road traffic showed that the level of vibrations mostly depends on roughness of road surface and the speed of moving cars [4]. The experimental study of transport induced soil vibrations by measuring frequency range of truck movement generated vibrations demonstrated that the dominant frequency of Rayleigh waves is in the range of 10 and 20 Hz [5]. Later investigation of road traffic induced ground vibrations suggested that the frequency of vibrations varies between 10 and 40 Hz, depending on the speed of vehicles and the roughness of roads [6].

Another source of anthropogenic ground vibrations is pile driving. Pile driving generates both body and surface waves that can possibly do damage to adjacent structures and carried out measurements of soil oscillations during pile driving in the construction of large-scale railway line in Taiwan [7]. The study showed that high frequency vibrations propagate faster and further from the source than low frequency vibrations. The research on ground vibrations during construction of bridge in Egypt demonstrated that soil type has a big influence on propagation of dynamic waves and stiff soils have a lower damping ratio compared to soft soils. There are concluded that the structures located closer than 50 meters from pile driving area are in danger of damage by ground vibrations. The measurements of pile driving induced ground vibrations indicated that frequency range of such vibrations is between 7 and 50 Hz, whereas the dominant frequency is about 10 Hz [8].

Blasting is a common method used in mining, quarrying, dams and roads construction and demolition of structures. The frequency of soil vibrations caused by blasting varies between 10 and 60 Hz [9]. The study suggests that the largest part of energy released by explosion propagates through dynamic waves at frequencies up to 50 Hz [2]. Another source of anthropogenic ground vibrations is dynamic compaction of soils and investigation showed that when hydraulic hammer compaction of soil is performed a weight of 27 - 400 kN is dropped from a certain height, which can vary between 1, 5 and 20 meters, depending on the existing base and required compaction level [10]. The study [9] indicates that dynamic compaction of soil generates 2 - 20 Hz vibrations while the dominant frequencies range from 3 to 12 Hz. Similar results are published by [2]. According to them, the biggest amount of soil oscillations induced by impact load of hydraulic hammer is characterized by 3 - 10 Hz frequency.

Many studies have shown that ground vibrations caused by anthropogenic sources have a negative effect on soil through

which vibrations propagate by movement of transverse and longitudinal waves. Longitudinal wave is a movement of the localized volume variation (or local density change) of the soil mass. The movement of particles caused by the propagation of this type of wave is a longitudinal compression-displacement movement. The propagation of the longitudinal wave depends on the material's resistance to one-sided deformation, hence, it depends on the model of the oedometric deformation of the soil [11]. The study [12] concluded that vibrations can affect the soil in four different ways: reduce the shear strength of soil; lead to excessive settlements; induce soil liquefaction; cause slopes instability. A decent amount of research has been conducted studying liquefaction process of sand due to ground vibrations in the last decades. However, only a few studies have been carried out on clayey soils. Moreover, most of the investigation of clay liquefaction has been conducted with low plasticity kaolinitic clays [13] and demonstrated that for low plasticity index IP (less than 4) liquefaction resistance of kaolin-sand mixture decreases when IP increases. However, the study [14] showed that the increase of plasticity index provides higher resistance to liquefaction, though plasticity index of the samples they used were higher than 10.

As it can be seen from the review of past works regarding vibrations effect on clay soil, there is a lack of experiments that show the effect of different frequency vibrations and their relation with basic clay properties, such as over consolidation ratio and plasticity index. Also, the behavior of illite clay under the existence of vibrations still needs to be studied. Therefore, this paper provides an experimental approach to anthropogenic vibration's effect on illite clay and the relation between vibration frequency and initial clay properties. Also, our method of research will allow simply and quickly evaluate the impact of factors caused by anthropogenic vibrations on the strength of soil.

Materials and Methods

Earlier studies in the research of clay soils showed that mechanical properties of clay depend on the mineral composition of the soil, as well as that the mineral composition of many clays depends on the geological formation conditions and is often unique in every part of the world. Therefore, when we started the research, we decided to perform X-ray analysis of clay in order to determine which minerals dominate in our analysed soil.

X-ray diffraction analysis was used to determine the mineral composition of clay. The X-ray diffraction analysis of clay was performed using the X-ray diffractometer Bruker D8 Advance. CuK α radiation and Ni filter were used. The results of X-ray analysis (Figure 1) show that tested clay contains quartz, calcite, dolomite, dickite, beidelite, muscovite and illite minerals. XRD analysis data suggests that tested clay is illite clay. Therefore, the results published in this paper have high importance. Most of the research carried out to evaluate the effect of soil vibrations on clay properties were performed using clay with a different another mineral structure, with predominance of kaolinite.

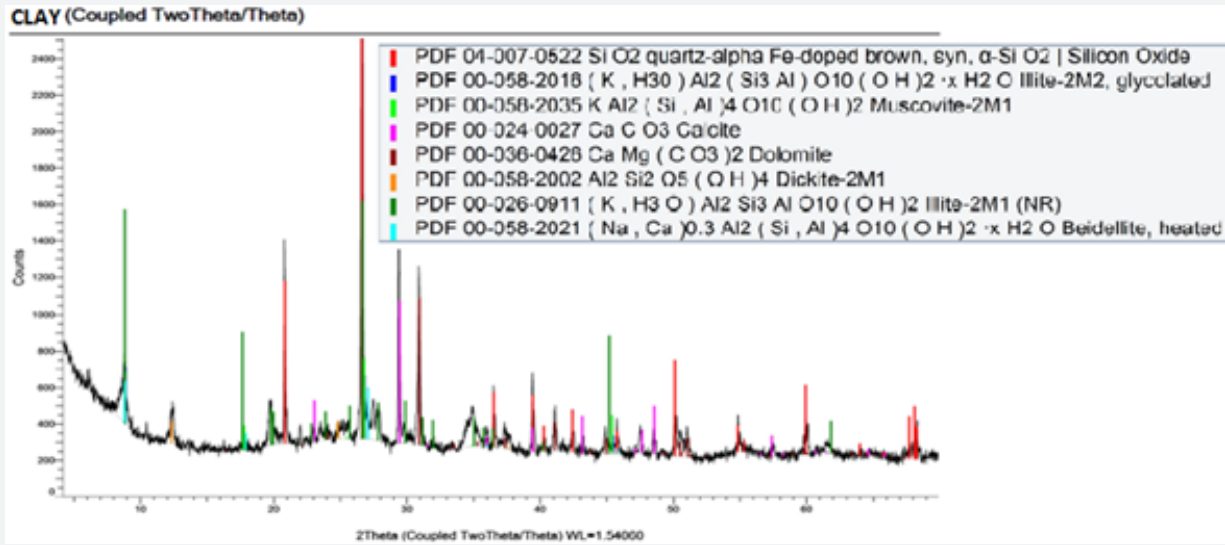

Figure 1: X-ray diffraction pattern of clay (in chemistry laboratory of Kaunas University of Technology).

The object of study in this paper is illite clay soil taken from middle of Lithuanian clay quarry. Clay monoliths were excavated from approximately 10 meters depth and transported to soil mechanics laboratory of Kaunas University of technology for the testing. Casagrande’s graphical method [15] was used to determine preconsolidation pressure p'_0 and over consolidation ratio OCR of this clay was calculated by equation:

$$OCR = \frac{p'_0}{p_0} \quad (1)$$

where: p_0 - present pressure.

The results showed that clay was over consolidated (OCR=1.8). In order to see the difference of over consolidated and normally consolidated clay behavior under the effect of vibrations, a part of clay monoliths have been dried in 105 °C until constant mass and powdered. As known the shear strength of soil can be expressed by Coulomb equation:

$$\tau_f = c + \sigma \tan \varphi \quad (2)$$

where: τ_f - failure shear stress;

c - cohesion;

σ - normal stress;

φ - angle of friction.

Cohesion and angle of friction of soil can be calculated knowing failure shear stress of specimen under each normal stress by standard method.

In order to check the change of strength of clay affected by vibrations, tests with clay of natural structure were performed, as well as samples of clays with different moisture and density were selected. In total five different types of clay samples were formed

and tested for physical properties and mechanical properties without and with the effect of vibrations.

Clay A - natural structure clay samples taken from clay monoliths. Clay B, C and D samples formed by mixing clay powder and water with mass ratio of powder and water content equal (Clay B=25%; Clay C=29%; Clay D=33%). Clay E - samples formed by mixing clay powder and water with mass ratio of powder and water content equal $w = 25\%$ and densified using Proctor’s compaction test.

The plasticity index IP and liquidity index IL of the samples were determined using the following equations:

$$I_p = w_L - w_p \quad (3)$$

$$I_L = \frac{w - w_p}{I_p} \quad (4)$$

where: w_L - liquidity limit;

w_p - plasticity limit;

w - natural water content in the field.

The initial physical properties of clay samples were determined by tests according standards [16-18]. The average results of the conducted experiments are given in .

The main aim of this paper is to investigate the different clay samples and their strength changes due to the effect of anthropogenic vibrations. Therefore, the most important part was to perform the oedometer tests and shear tests of clay samples under standard conditions and under the effect of vibrations. Field laboratory special apparatus of Litvinova (PLL-9) [19] was chosen as the equipment for this study (see Figure 2 and Figure 3) because it could be assembled to a vibrating table for testing clay behavior

under the effect of vibrations. The main part is stand generating waves (Brüel & Kjør, type 4802), with changeable parameters. The periodic vibrations that are caused by many types of machinery operating in periodic cycles, for example: pumps, vibrating rollers, compressors and fans. This device is suitable for our research since it can be used for modelling parameters of different frequencies,

amplitudes and time in laboratory conditions. After analysing the work of other authors who's investigated the vibrations caused by anthropogenic factors (trains, heavy machinery, construction equipment), we selected the following parameters for the test methods: vibration frequency - 50 Hz, and amplitude - 0.3 mm.

Table 1: Initial physical properties of clay samples.

Sample name	Water content w, %	Density ρ , Mg/m ³	Void ratio	Consistency index I_c	Liquidity index I_L	OCR
Clay A	30	2.01	0.512	0.82	0.176	1.8
Clay B	25	1.92	0.638	1	-0.003	1
Clay C	29,00	1.892	0.602	0.85	0.153	1
Clay D	33	1.874	0.56	0.69	0.309	1
Clay E	25	1.962	0.526	1.03	-0.025	1.5

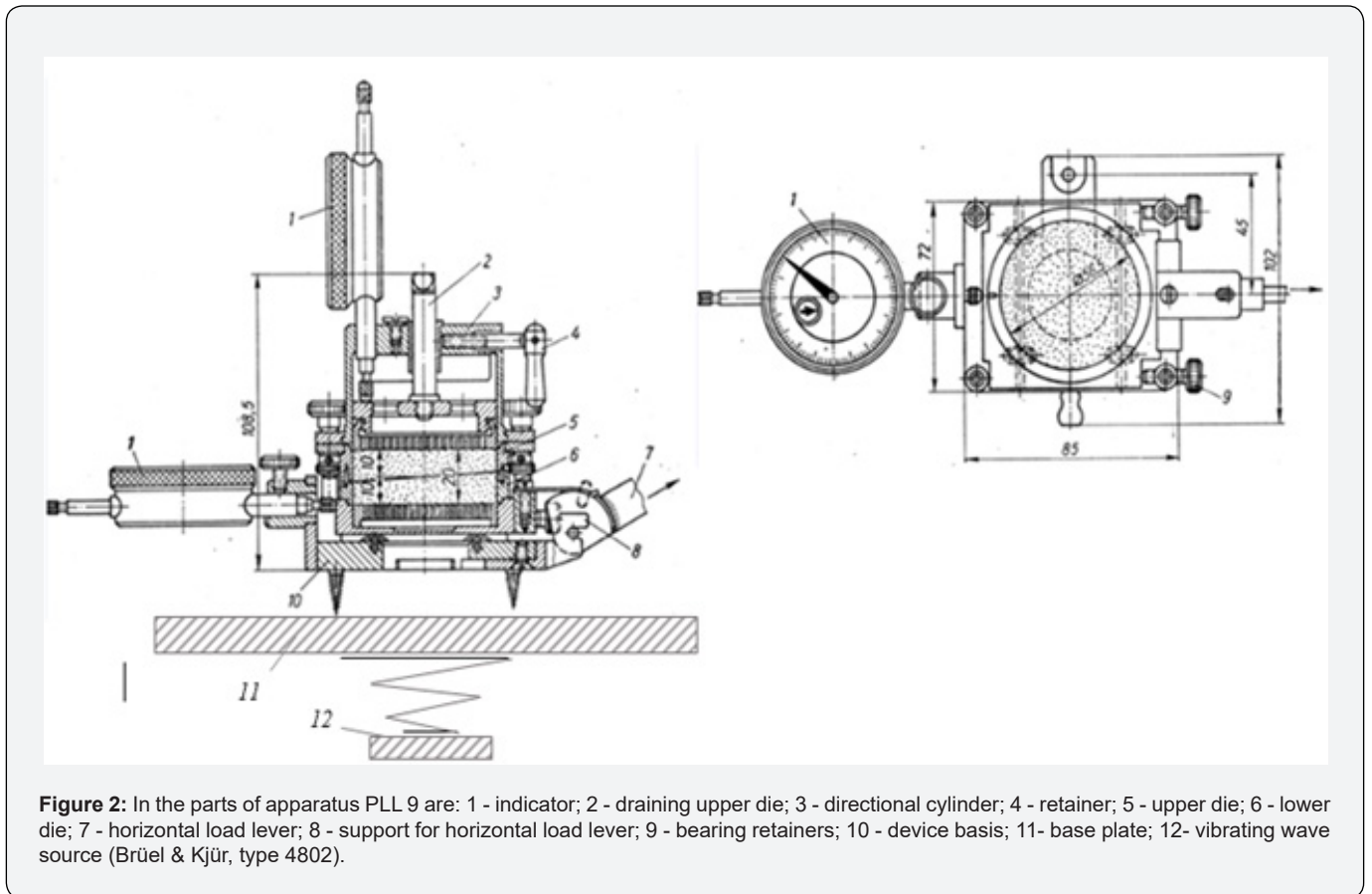

An amplitude of this size was chosen to evaluate the most unfavorable test case that occurs when methods are near or on slopes. Note that the amplitude of the vibrations during all experiments using vibrating table was constant and set to be 0.3 mm so that the effect of vibrations on illite clay soil mechanical properties could be determined based only on the vibrations existence and it's frequency. Those loads were mainly used

for study as this value represents most of the anthropogenic vibrations mentioned in this paper.

To quickly determine the strength of plastic soils, it is useful to use the PLL-9 mobile field apparatus. To ensure the accuracy of the field laboratory data, comparative tests were conducted with our standardized equipment. The soil testing results were

compared with the same primer using only different devices. For comparison, the reliability of the results used clay type E (). A total of 48 tests were conducted. The tests were carried out in accordance with standard test methods ISO/ITS 17892-8 and

ISO/ITS 17892-10. The strength of the clay were determined by calculating the angle of internal friction and cohesion. The results are shown in Table 2.

Table 2: Comparative test results.

Laboratory test	Angle of friction (°)	Cohesion (kPa)
Field laboratory PLL-9	6	54.4
Digital tritest (ISO/ITS 17892-8)	7	53.8
Direct shear tests (ISO/ITS 17892-10)	7	53.6

The samples of illite clay used for testing were cylindrical shape of 56.5 mm diameter and 20 mm height (Figure 2). Oedometer tests have been performed with 4 different normal stresses: 50 kPa, 100 kPa, 200 kPa and 300 kPa. Dial indicators were used to measure strain of samples with accuracy of 0.01 mm. Shear tests on clay have been performed with three different normal stresses: 100 kPa, 200 kPa and 300 kPa. Horizontal load was increased with a step of 4.8 kPa shear stress on clay specimen until it reached limit state and failure shear stress.

The studies were conducted in the accredited laboratory of Building Research Centre of Kaunas University of Technology. The

difference in the results is insignificant, so we can say that we can use the PLL-9 field laboratory for research purposes.

Results

The results of oedometer tests are given as stress-strain diagrams where the vertical axis represents normal stress acting on clay sample and horizontal axis shows the strain of the sample. The stress-strain relationship of Clay A without the effect of vibrations is illustrated in Figure 4 while the results of the same test performed with 50 Hz vibrations are given in Figure 5.



Figure 3: View of shear test using vibrating table (in laboratory of vibration engineering of Kaunas University of Technology).

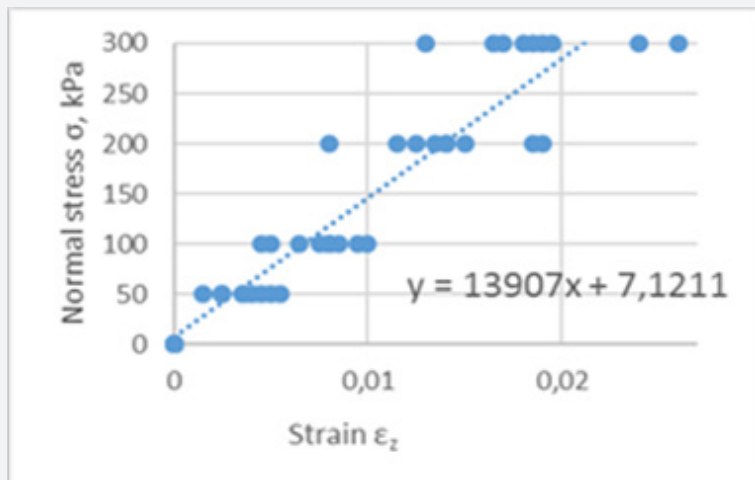

Figure 4: Clay A stress-strain diagram under standard conditions.

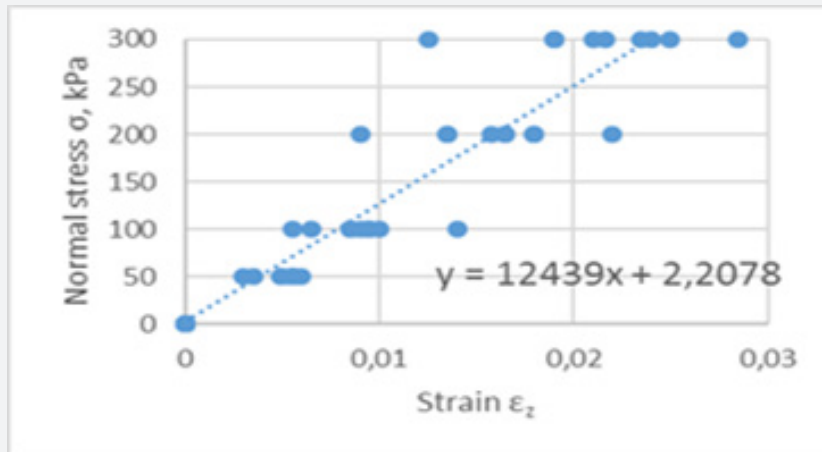

Figure 5: Clay A stress-strain diagram under 50 Hz vibrations.

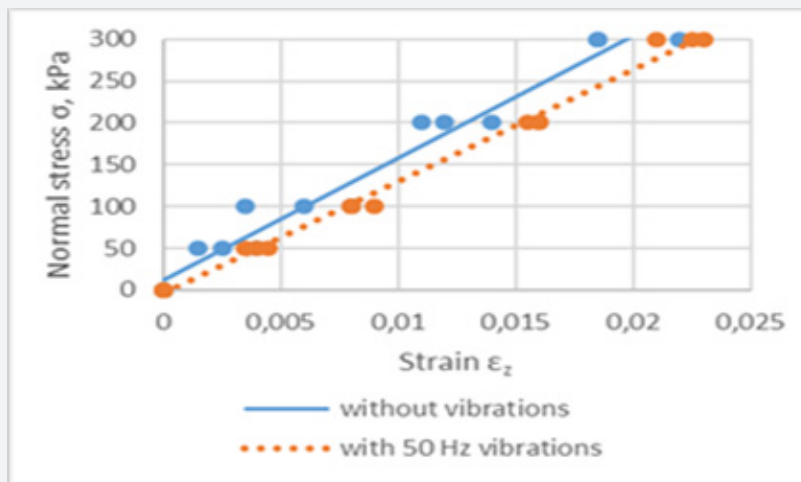

Figure 6: Clay B stress-strain diagrams.

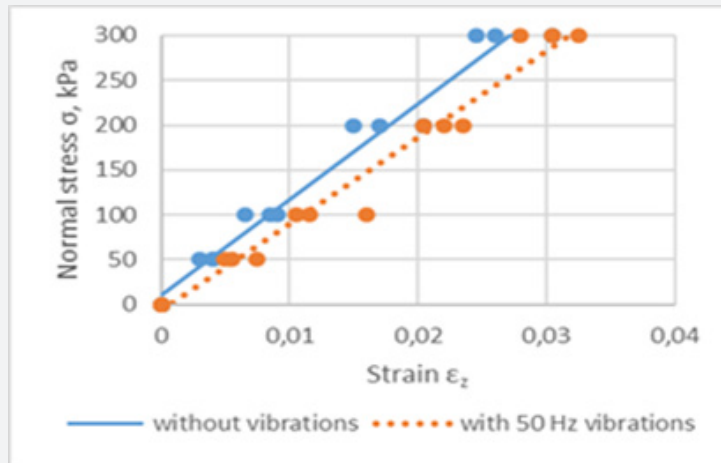

Figure 7: Clay C stress-strain diagrams.

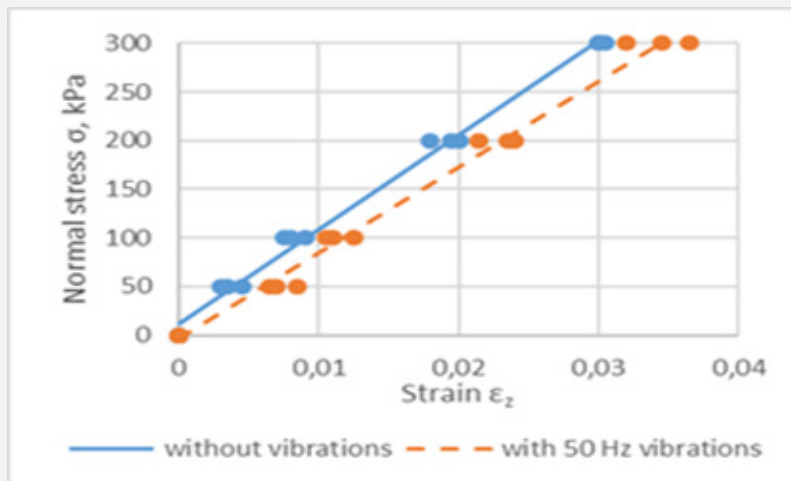

Figure 8: Clay D stress-strain diagrams.

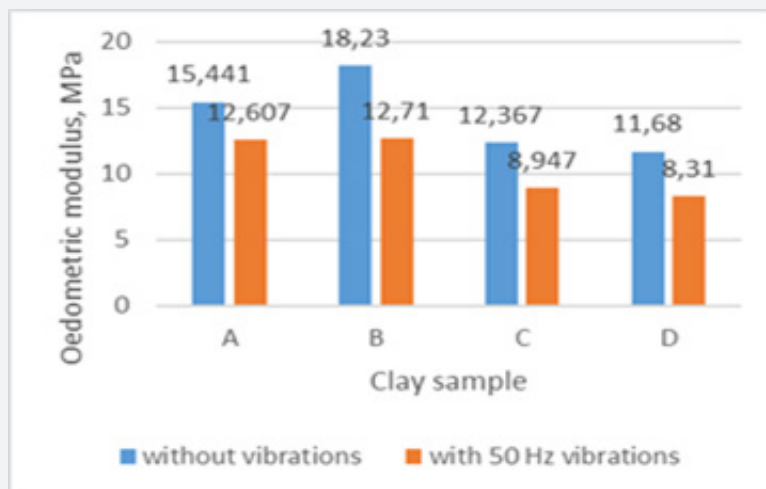

Figure 9: Overall results of oedometric tests.

To study which physical parameter of clay determines the diagrams of Clay B, C and D samples are given below (Figures 6-9).
 reduction magnitude of oedometric modulus stress-strain

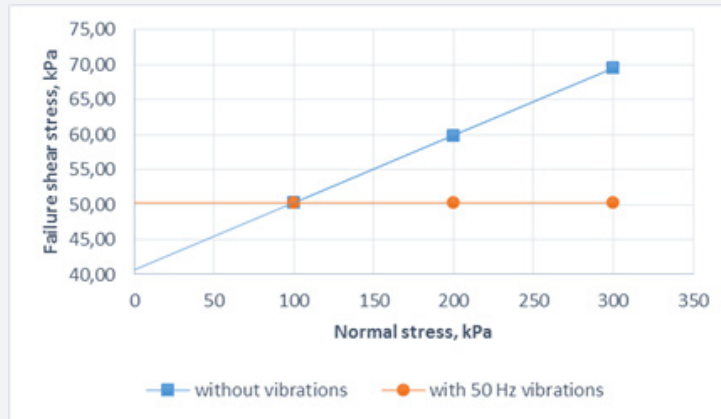

Figure 10: Clay A shear test results.

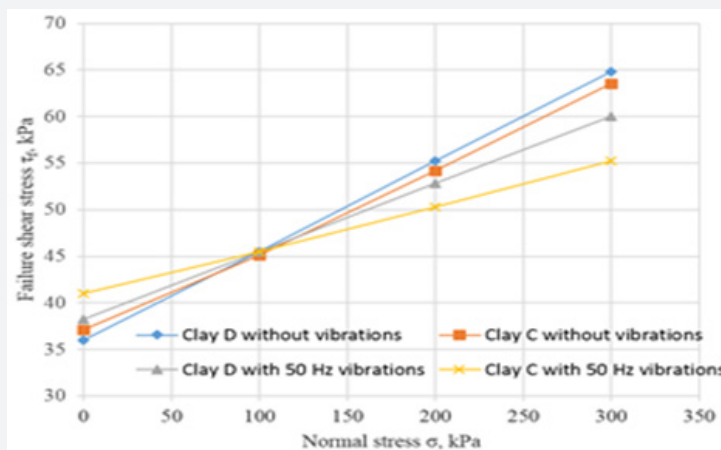

Figure 11: Clay C and D shear tests results.

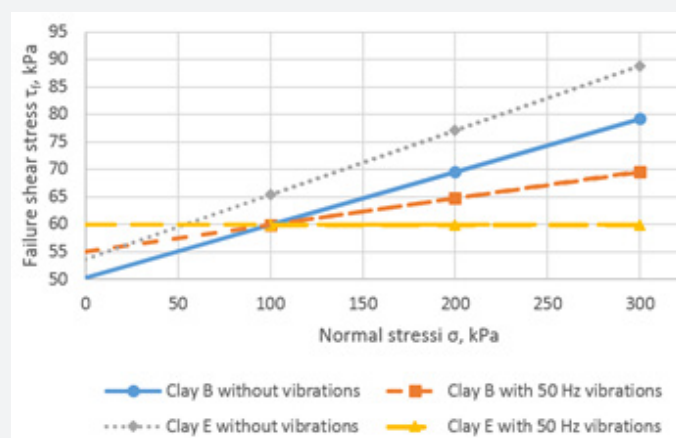

Figure 12: Clay B and E shear tests results.

The results of shear tests performed with Clay A are illustrated in Figure 10 below.

To get a better understanding of vibrations influence on the main strength of clay the shear tests results for the rest clay samples are shown in Figures 11,12.

From these results it becomes evident that the over consolidation ratio has a relationship with the vibrations frequency that increases the pore water pressure in clay the most.

Discussion

The stress-strain relationship of Clay A without the effect of vibrations in Figure 4 and same test performed with 50 Hz vibrations in Figure 5 show that 50 Hz vibrations had a negative effect on clay soil oedometric strength. The reduction of oedometric strength due to the effect of vibrations is equal to 18.4 % according to the results.

By analyzing the stress-strain relationships in Figure 6 - Figure 9 can be seen that for all 3 samples the 50 Hz vibrations had the same effect - in all cases the oedometric strength reduced by approximately 30 % when the clay sample was subjected to vibrations during the test. Interestingly, the water content of clay only had a relationship with the value of oedometric strength but no relationship between natural water content and oedometric strength reduction due to the effect of vibrations was observed from the tests. However by comparing Clay A results with Clay B, C, and D oedometer test results it can be noticed that the over consolidation ratio has a relation to the reduction of oedometric strength. An overconsolidated clay (OCR=1.8) subjected to 50 Hz vibrations lost 18.4 % of its initial oedometric strength while the oedometric strength reduction of normally consolidated clay in all cases was close to 30 %. Shear tests with clay A when the samples were affected by 50 Hz vibrations in Figure 10 show – the shear failure envelope changed its shape from an inclined line into a horizontal line. This is the change of shear failure envelope that would be expected in the case then the excess pore water pressure generated by the effect of vibrations on clay sample resulted in all clay pores becoming saturated with water which directly led to complete loss of internal angle of friction of Clay A ($\varphi=0$) and the strength is constant and depends on undrained shear stress which equal to the cohesion of clay.

The results in Figure 11 suggest that 50 Hz frequency vibrations are not as dangerous in terms of clay liquefaction for normally consolidated clay samples. Here, the effect of 50 Hz vibrations is the same as it was for Clay D – the reduction of the internal angle of friction by 50 %. Figure 12 clearly shows that 50 Hz vibrations act differently on the clay samples with the same natural water content but with a different over consolidation ratio. Clay B is affected by 50 Hz vibrations in the same way as other normally consolidated clay samples (Clay C and D). However, Clay E reacted to the effect of vibrations in the same manner as the other over-consolidated clay sample (Clay A) - the internal angle of friction was reduced to zero.

In designing or evaluating the stability of clay slopes, embankments or excavations in urban areas with a large number of equipment that can cause anthropogenic soil vibrations, the most unfavorable values of clay strength should be taken into account in calculations and evaluations, i.e. when the clay soil will be saturated with water (for example, during the spring flood, or during the rainy season) and during the effect of anthropogenic factors causing soil vibrations (e.g., trains, heavy machinery, construction tremblers, etc.), these factors will lead to paired pressure and internal friction angle will decrease to 0. Our studies have shown that shear tests with clay samples under the effect of vibrations changes when it is subjected to a specific vibration frequency. In some tests, the behavior of clay samples was as in undrained conditions even though the tests were performed in consolidated drained (CD) conditions. Vibrations caused the emergence of an excess pore water pressure which led to the complete loss of internal angle of friction for A and E cases.

Conclusion

The present study showed that vibrations have a negative effect on oedometric modulus of clay. Clay samples subjected to 50 Hz had bigger strain under the same normal stress than during experiments without the effect of vibrations and it can be use in design situations of estimation where are possible the wheels traffic load. The relation between clay over consolidation ratio and the reduction of internal friction angle has been observed during the investigation. Normally consolidated clay with different water content subjected to 50 Hz vibrations lost approximately 30 % of it is initial oedometric strength while the oedometric strength of over consolidated clay (OCR=1.8) reduced by 18.4 % under the same vibration frequency. Shear tests with Clay A showed that 50 Hz vibrations cause the effect of internal friction angle reduced to zero in the overconsolidated illite clay. For normally consolidated clay (samples B, C, D) 50 Hz vibrations reduced the internal angle of friction in half but did not fill all clay pores with water. Testing with clay samples over consolidated by compaction using Proctor's densification method (Clay E) showed that 50 Hz vibrations caused the shear failure envelope to change its shape from inclined to the horizontal line - the internal angle of friction reduced to 0°.

References

1. Lombaert G, Degrande G (2009) Ground-borne vibrations due to static and dynamic axle loads of InterCity and high-speed trains. *J Sound and Vibration* 319: 1036-1066.
2. Kim DS, Lee JS (2000) Propagation and attenuation characteristics of various ground vibrations. *Soil Dynamics and Earthquake Engineer* 19: 115-126.
3. Wanming Z, Zhenxing X, Song X (2010) Prediction of high speed train induced ground vibration based on train-track ground system model. *Earthquake Eng & Eng Vibrat* 9(4): 545-554.
4. Agostinacchio M, Ciampa D, Olita S (2014) The vibrations induced by surface irregularities in road pavements - a Matlab approach. *Eur Transport Res Rev* 6(3): 267-275.
5. Taniguchi E, Sawada K (1979) Attenuation with distance of traffic-induced vibrations. *Soils and Found* 19(2): 16-28.

6. Al-Hunaidi MO, Rainer JH (1991) Remedial measures for traffic-induced vibrations at a residential site. Part 1: Field tests. Appl Acoustics 19(1): 3-13.
7. Hwang JH, Liang N, Chen CH (2001) Ground response during pile driving. J Geotech Geoenv Eng 127(11): 939-949.
8. Abdel-Rahman S (2002) Vibration associated with pile driving and its effects on nearby historical structures", Paper presented at the 20th International Modal Analysis Conference (IMAC), Los Angeles, CA, USA.
9. Svinkin MR (2008) Soil and Structure Vibrations from Construction and Industrial Sources. Paper presented at the 6th Int. Conf. on Case Histories in Geotechnical Engineering, Arlington, VA, August 11-16.
10. Pan JL, Selby AR (2002) Simulation of dynamic compaction of loose granular soils. Adv Engineering Software 33: 631-640.
11. Deckner F (2013) Ground vibrations due to pile and sheet pile driving - influencing factors, predictions and measurements", doctoral thesis, Royal Institute of Technology, Stockholm, XV, 110.
12. Ishihara K (1993) Liquefaction and flow failure during earthquakes. Geotechnique 43(3): 351-415.
13. Prakash S, Sandoval J (1992) Liquefaction of low plasticity silts. Soil Dynamics and Earthquake Eng 11(7): 373-379.
14. Hyodo M, Hyde AFL, Yamamoto Y, Fujii T (1999) Cyclic shear strength of undisturbed and remoulded marine clays. Soils and Found 39(2): 45-48.
15. Robinson R, Allam M (1998) Analysis of Consolidation Data by a Non-Graphical Matching Method. Geotechnical Testing J 21(2): 140-143.
16. EN ISO/TS 17892-12:2018 (2018) Geotechnical investigation and testing - Laboratory testing of soils - Part 12: Determination of Atterberg limits.
17. EN ISO/TS 17892-1:2014 (2014) Geotechnical investigation and testing - Laboratory testing of soil - Part 1: Determination of water content.
18. EN ISO 11272:2017 (20107) Soil quality - Determination of dry bulk density.
19. Litvinova PLL-9 Field Laboratory (2012) Instruction for the study of building properties of soils, Sankt-Peterburg, Russia.



This work is licensed under Creative Commons Attribution 4.0 License
DOI: [10.19080/CERJ.2024.15.555903](https://doi.org/10.19080/CERJ.2024.15.555903)

Your next submission with Juniper Publishers will reach you the below assets

- Quality Editorial service
- Swift Peer Review
- Reprints availability
- E-prints Service
- Manuscript Podcast for convenient understanding
- Global attainment for your research
- Manuscript accessibility in different formats
(Pdf, E-pub, Full Text, Audio)
- Unceasing customer service

Track the below URL for one-step submission
<https://juniperpublishers.com/online-submission.php>